

- 1、Material:steel Q235B
- 2、Hot-dip galvanized not less than 80um
- 3、Powder coated thickness not less than 100um,color is customized.

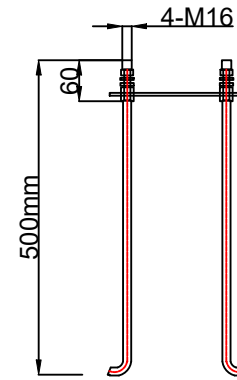

ANCHOR BOLT DETAIL

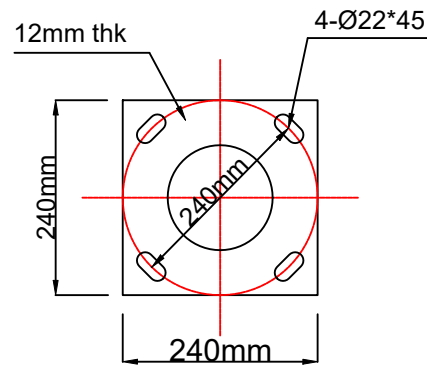

BASE PLATE

NO.		PROJECT TEAM		6M Pole
DESIGNED BY		PROJECT NUMBER		
DRAWN BY		REVISION(S)		
CHECKED BY		DATE		