

1. Material :steel Q235B
- 2, hot dip galvanized not less than 80um
- 3, powder coating thickness is not less than 100um, color can be customized.

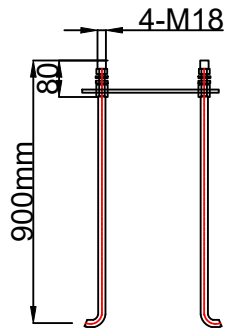

ANCHOR BOLT DETAIL

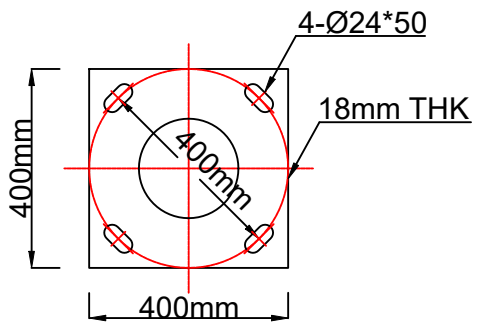

BASE PLATE

NO.		PROJECT TEAM		9M SOLAR STREET LIGHT
DESIGNED BY		PROJECT NUMBER		
DRAWN BY		REVISION(S)		
CHECKED BY		DATE		